

Video Test Pattern Generator v8.2

LogiCORE IP Product Guide

Vivado Design Suite

PG103 November 4, 2022

Xilinx is creating an environment where employees, customers, and partners feel welcome and included. To that end, we're removing non-inclusive language from our products and related collateral. We've launched an internal initiative to remove language that could exclude people or reinforce historical biases, including terms embedded in our software and IPs. You may still find examples of non-inclusive language in our older products as we work to make these changes and align with evolving industry standards. Follow this [link](#) for more information.



Table of Contents

IP Facts

Chapter 1: Overview

Navigating Content by Design Process	5
Feature Summary	5
Applications	6
Licensing and Ordering	6

Chapter 2: Product Specification

Standards	7
Performance	7
Resource Utilization	9
Core Interfaces and Register Space	9

Chapter 3: Designing with the Core

General Design Guidelines	26
Clock, Enable, and Reset Considerations	27
System Considerations	27

Chapter 4: Design Flow Steps

Customizing and Generating the Core	29
Constraining the Core	32
Simulation	33
Synthesis and Implementation	33

Chapter 5: Detailed Example Design

Synthesizable Example Design	35
------------------------------------	----

Chapter 6: Test Bench

Appendix A: Verification, Compliance, and Interoperability

Simulation	40
Hardware Testing	40

Interoperability	41
Appendix B: Upgrading	
Migrating to the Vivado Design Suite.....	42
Upgrading in Vivado Design Suite.....	42
Appendix C: Debugging	
Finding Help on Xilinx.com	45
Debug Tools	46
Hardware Debug	46
Vivado Synthesis Debug	47
Appendix D: Additional Resources and Legal Notices	
Xilinx Resources	48
Documentation Navigator and Design Hubs	48
References	49
Revision History	50
Please Read: Important Legal Notices	50

Introduction

The Xilinx® LogiCORE™ IP Video Test Pattern Generator core generates test patterns for video system bring up, evaluation, and debugging. The core provides a wide variety of tests patterns enabling you to debug and assess video system color, quality, edge, and motion performance. The core can be inserted in an AXI4-Stream video interface that allows user-selectable pass-through of system video signals or insertion of test patterns.

Features

- Color bars
- Zone plate with adjustable sweep and speed
- Temporal and spatial ramps
- Moving box with selectable size and color over any available test pattern
- RGB, YUV 444, YUV 422, YUV 420
- AXI4-Stream data interfaces
- AXI4-Lite control interface
- Supports 8, 10, 12, and 16-bits per component input and output
- Supports spatial resolutions from 64 x 64 up to 15360 x 8640
 - Supports 8K60 in all supported device families ⁽¹⁾

1. Performance on low power devices may be lower.

LogiCORE IP Facts Table	
Core Specifics	
Supported Device Family ⁽¹⁾	Versal® ACAP, UltraScale+™ Families, UltraScale™ Architecture, 7 Series
Supported User Interfaces	AXI4-Lite, AXI4-Stream ⁽²⁾
Resources	Performance and Resource Utilization web page
Provided with Core	
Documentation	Product Guide
Design Files	Not Provided
Example Design	Yes
Test Bench	Not Provided
Constraints File	XDC
Simulation Models	Encrypted RTL, VHDL, or Verilog Structural
Supported Software Drivers ⁽³⁾	Standalone, V4L2
Tested Design Flows ⁽⁴⁾	
Design Entry Tools	Vivado® Design Suite
Simulation	For supported simulators, see the Xilinx Design Tools: Release Notes Guide .
Synthesis Tools	Vivado Synthesis
Support	
Release Notes and Known Issues	Master Answer Record: 54536
All Vivado IP Change Logs	Master Vivado IP Change Logs: 72775
Xilinx Support web page.	

Notes:

1. For a complete listing of supported devices, see the Vivado IP Catalog.
2. Video protocol as defined in the *Video IP: AXI Feature Adoption* section of *AXI Reference Guide* [Ref 1].
3. Standalone driver details can be found in the Vitis directory (<install_directory>/Vitis/<release>/data/embeddedsw/doc/xilinx_drivers.htm).
4. For the supported versions of the tools, see the [Xilinx Design Tools: Release Notes Guide](#).

Overview

The Video Test Pattern Generator core generates video test patterns which can be used when developing video processing cores or bringing up a video system. The test patterns can be used to evaluate and debug color, quality, edge, and motion performance, debug and assess video system color, quality, edge, and motion performance of a system, or stress the video processing to ensure proper functionality.

Navigating Content by Design Process

Xilinx® documentation is organized around a set of standard design processes to help you find relevant content for your current development task. This document covers the following design processes:

- **Hardware, IP, and Platform Development:** Creating the PL IP blocks for the hardware platform, creating PL kernels, subsystem functional simulation, and evaluating the Vivado timing, resource and power closure. Also involves developing the hardware platform for system integration. Topics in this document that apply to this design process include:
 - [Port Descriptions](#)
 - [Register Space](#)
 - [Customizing and Generating the Core](#)
 - [Detailed Example Design](#)

Feature Summary

The Video Test Pattern Generator core produces the following patterns in RGB, YUV 444, YUV 422, or YUV 420 video format. The YUV color space is based off of the ITU-R BT.601 standard:

- Video input pass through
- Horizontal ramp
- Vertical ramp
- Temporal ramp
- Flat fields (red, green, blue, black and white)

- Combined vertical and horizontal ramp
 - Color bars
 - Color sweep
 - Tartan bars
 - DisplayPort
 - Zone plate
 - Cross hairs
 - Cross hatch
 - Solid box
 - Motion effect for ramps, zone plate, and solid box
-

Applications

The horizontal and vertical ramps can be used to test system linearity. The temporal ramp can be used to test the integrity of frame buffers that exist in the system. Flat fields are useful for detecting possible chroma issues with video processing cores. Color bars and tartan bars are used to verify the proper reproduction of color correction functions and the color gamut of a monitor.

Licensing and Ordering

This Xilinx® LogiCORE™ IP module is provided at no cost under the terms of the [Xilinx Core License Agreement](#). The module is shipped as part of the Vivado® Design Suite.

For more information, visit the Video Test Pattern Generator [product web page](#).

Information about other Xilinx LogiCORE IP modules is available at the [Xilinx Intellectual Property](#) page. For information on pricing and availability of other Xilinx LogiCORE IP modules and tools, contact your [local Xilinx sales representative](#).

Product Specification

Standards

The Video Test Pattern Generator core is compliant with the AXI4-Stream Video Protocol and AXI4-Lite interconnect standards. Refer to the *Video IP: AXI Feature Adoption* section of the *Vivado AXI Reference Guide* (UG1037) [Ref 1] for additional information.

Performance

The following sections detail the performance characteristics of the Video Test Pattern Generator core. For full details about performance and resource utilization, visit the [Performance and Resource Utilization web page](#).

Maximum Frequencies

There are no IP specific restrictions on the maximum achievable clock frequency. The restriction is dependent on if the design can meet timing or not. Meeting timing is dependent on the clock frequency selected, and is impacted by resource utilization, tool options, additional logic in the device and the version of tool used. For more information, see Xilinx® timing closure documentation as well as the fabric data-sheets below. The frequency ranges specified in these documents must be adhered to for proper transceiver and core operation.

- *Kintex UltraScale FPGAs Data Sheet: DC and AC Switching Characteristics* (DS892) [Ref 9]
- *Virtex UltraScale FPGAs Data Sheet: DC and AC Switching Characteristics* (DS893) [Ref 10]
- *Kintex-7 FPGAs Data Sheet: DC and AC Switching Characteristics* (DS182) [Ref 11]
- *Virtex-7 FPGAs Data Sheet: DC and AC Switching Characteristics* (DS183) [Ref 12]
- *Artix-7 FPGAs Data Sheet: DC and AC Switching Characteristics* (DS181) [Ref 13]
- *Zynq-7000 SoC (Z-7007S, Z-7012S, Z-7014S, Z-7010, Z-7015, and Z-7020) Data Sheet: DC and AC Switching Characteristics* (DS187) [Ref 14]

- *Zynq-7000 SoC (Z-7030, Z-7035, Z-7045, and Z-7100) Data Sheet: DC and AC Switching Characteristics (DS191) [Ref 15]*
- *Kintex UltraScale+ FPGAs Data Sheet: DC and AC Switching Characteristics (DS922) [Ref 16]*
- *Virtex UltraScale+ FPGA Data Sheet: DC and AC Switching Characteristics (DS923) [Ref 17]*
- *Zynq UltraScale+ MPSoC Data Sheet: DC and AC Switching Characteristics (DS925) [Ref 18]*
- *Zynq UltraScale+ RFSoc Data Sheet: DC and AC Switching Characteristics (DS926) [Ref 19]*
- *Versal AI Core Series Data Sheet: DC and AC Switching Characteristics (DS957) [Ref 20]*

Throughput

The Video Test Pattern Generator core supports bidirectional data throttling between its AXI4-Stream Slave and Master interfaces. If the slave side data source is not providing valid data samples (`s_axis_video_tvalid` is not asserted), the core cannot produce valid output samples after its internal buffers are depleted. Similarly, if the master side interface is not ready to accept valid data samples (`m_axis_video_tready` is not asserted), the core cannot accept valid input samples once its buffers become full.

If the master interface is able to provide valid samples (`s_axis_video_tvalid` is High) and the slave interface is ready to accept valid samples (`m_axis_video_tready` is High), typically the core can process and produce 1, 2, 4, or 8 pixels specified by Samples Per Clock in GUI per `AP_CLK` cycle.

However, at the end of each scan line and frame the core flushes internal pipelines for seven clock cycles, during which the `s_axis_video_tready` is deasserted signaling that the core is not ready to process samples.

When the core is processing timed streaming video (which is typical for most video sources), the flushing periods coincide with the blanking periods; therefore, do not reduce the throughput of the system.

When the core is processing data from a video source which can always provide valid data, e.g., a frame buffer, the throughput of the core can be defined as follows:

$$R_{MAX} = f_{APCLK} \times \frac{ROWS}{ROWS} \times \frac{COLS}{COLS + 17} \times PPC \quad \text{Equation 2-1}$$

In numeric terms, 1080P/60 represents an average data rate of 124.4 MPixels/second (1080 rows x 1920 columns x 60 frames / second x 1 pixel per clock), and a burst data rate of 148.5 MPixels/sec.

To ensure that the core can process 124.4 MPixels/second, it needs to operate minimally at:

$$f_{APCLK} = R_{MAX} \times \frac{ROWS}{ROWS} \times \frac{COLS + 17}{COLS} \times PPC = 124.4 \times \frac{1080}{1080} \times \frac{1937}{1920} \times 1 = 125.5 \quad \text{Equation 2-2}$$

When operating on a streaming video source (i.e., not frame buffered data), the core must operate minimally at the burst data rate. For example, 148.5 MHz for a 1080P60 video source.

Resource Utilization

For details about resource utilization, visit [Performance and Resource Utilization](#).

Core Interfaces and Register Space

Port Descriptions

The Video Test Pattern Generator core uses industry standard control and data interfaces to connect to other system components. The following sections describe the various interfaces available with the core. [Figure 2-1](#) illustrates an I/O diagram of the TPG core. Some signals are optional and not present for all configurations of the core. The AXI4-Lite interface is always available while the AXI4-Stream slave interface is optional.

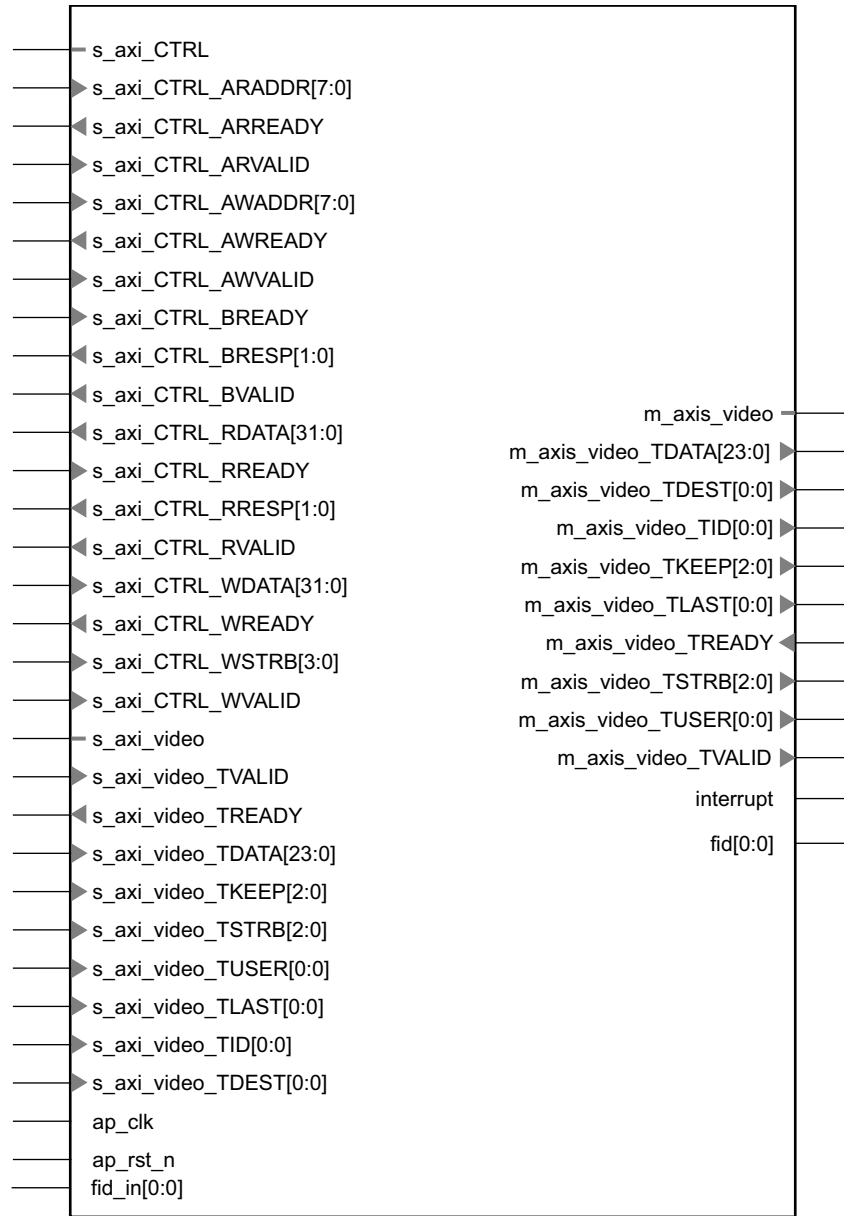

X15054-092515

Figure 2-1: TPG Core Top-Level Signaling Interface

Common Interface Signals

Table 2-1 summarizes the signals which are either shared by, or not part of the dedicated AXI4-Stream data or AXI4-Lite control interfaces.

Table 2-1: Common Interface Signals

Signal Name	Direction	Width	Description
AP_CLK	In	1	Video Core Clock
AP_RST_N	In	1	Video Core active-Low reset

Table 2-1: Common Interface Signals (Cont'd)

Signal Name	Direction	Width	Description
INTERRUPT	Out	1	Interrupt Request Pin
FID_IN	In	1	Input Field ID port
FID	Out	1	Field ID port

The `AP_CLK` and `AP_RST_N` signals are shared between the core, the AXI4-Stream data interfaces, and the AXI4-Lite control interface. The `INTERRUPT` pin is not supported and reserved for future use.

AP_CLK

The AXI4-Stream and AXI4-Lite interfaces must be synchronous to the core clock signal `AP_CLK`. All AXI4-Stream interface input signals and AXI4-Lite control interface input signals are sampled on the rising edge of `AP_CLK`. All AXI4-Stream output signal changes occur after the rising edge of `AP_CLK`.

AP_RST_N

The `AP_RST_N` pin is an active-low, synchronous reset input pertaining to both AXI-Lite and AXI4-Stream interfaces. When `AP_RST_N` is set to 0, the core resets at the next rising edge of `AP_CLK`.

FID_IN

The `FID_IN` is an active-Low pin used for pass-through mode, where in the Field ID input to this block is passed to the FID port of the block.

FID

The `FID` is an active-Low pin used as Field ID for AXI4-Stream bus. It is used only for interlaced video. When `FID` is set to 0, it is an even field and when `FID` is set to 1, it is an odd field. This bit is sampled coincident with the SOF on the AXI4-Stream bus. If the signal is not used (i.e., the progressive video input stream), the output must be set low.

Data Interface

The TPG core receives and transmits data using AXI4-Stream interfaces that implement a video protocol as defined in the *Video IP: AXI Feature Adoption* section of the *Vivado AXI Reference Guide (UG1037)* [Ref 1].

AXI4-Stream Signal Names and Descriptions

Table 2-2 describes the AXI4-Stream signal names and descriptions.



IMPORTANT: In Table 2-2, $TotalDataWidth = data_width * number_of_components * samples_per_clock$. The three values correspond to Maximum Data Width, Number of Video Components and Samples Per Clock in GUI, respectively. Refer to Chapter 4, Design Flow Steps for more information.

Table 2-2: AXI4-Stream Data Interface Signal Descriptions

Signal Name	Direction	Width	Description
s_axis_video_tdata	In	$(TotalDataWidth+7)/8*8$	Input Video Data
s_axis_video_tvalid	In	1	Input Video Valid Signal
s_axis_video_tready	Out	1	Input Ready
s_axis_video_tuser	In	1	Input Video Start Of Frame
s_axis_video_tlast	In	1	Input Video End Of Line
s_axi_video_tstrb	In	s_axis_video tdata/8	Input video data strobe indicates whether the content of the associated byte of TDATA is processed as a data byte or a position byte
s_axi_video_tkeep	In	s_axis_video tdata/8	Input video byte qualifier that indicates whether the content of the associated byte of TDATA is processed as part of the data stream
s_axi_video_tid	In	1	Input video data stream identifier
s_axi_video_tdest	In	1	Input video data routing information
m_axis_video_tdata	Out	$(TotalDataWidth+7)/8*8$	Output Video Data
m_axis_video_tvalid	Out	1	Output Valid
m_axis_video_tready	In	1	Output Ready
m_axis_video_tuser	Out	1	Output Video Start Of Frame
m_axis_video_tlast	Out	1	Output Video End Of Line
m_axi_video_tstrb	Out	m_axis_video tdata/8	Output video data strobe indicates whether the content of the associated byte of TDATA is processed as a data byte or a position byte
m_axi_video_tkeep	Out	m_axis_video tdata/8	Output video byte qualifier that indicates whether the content of the associated byte of TDATA is processed as part of the data stream

Table 2-2: AXI4-Stream Data Interface Signal Descriptions (Cont'd)

Signal Name	Direction	Width	Description
m_axi_video_tid	Out	1	Output video data stream identifier
m_axi_video_tdest	Out	1	Output video data routing information

Video Data

The AXI4-Stream interface specification restricts TDATA widths to integer multiples of 8 bits. Therefore, any bit data must be padded with zeros on the MSB to form a N*8 bit wide vector before connecting to s_axis_video_tdata. Padding does not affect the size of the core.

Similarly, data on the TPG output m_axis_video_tdata is packed and padded to multiples of 8 bits as necessary. Zero padding the most significant bits is only necessary for 10 and 12 bit wide data. Figure 2-2 through Figure 2-6 explain the pixel mapping of AXI4-Stream interface with 2 pixels per clock and 10 bits per component configuration for all supporting color formats. Zero padding (bits [63:60]) is not shown in the figures. Given that TPG requires hardware configuration for 3 component video, the AXI4-Stream Subset Converter is needed to hook up with other IPs of 2 component video interface in YUV 4:2:2 and YUV 4:2:0 color format. Refer to Appendix B, Upgrading and AXI4-Stream Video IP and System Design Guide (UG934) [Ref 4] for more information.

59:50	49:40	39:30	29:20	19:10	9:0
R1	B1	G1	R0	B0	G0

Figure 2-2: Dual Pixels per Clock, 10 bits per Component Mapping for RGB

59:50	49:40	39:30	29:20	19:10	9:0
V1	U1	Y1	V0	U0	Y0

Figure 2-3: Dual Pixels per Clock, 10 bits per Component Mapping for YUV 4:4:4

59:50	49:40	39:30	29:20	19:10	9:0
		V0	Y1	U0	Y0

Figure 2-4: Dual Pixels per Clock, 10 bits per Component Mapping for YUV 4:2:2

59:50	49:40	39:30	29:20	19:10	9:0
		V0	Y1	U0	Y0

Figure 2-5: Dual Pixels per Clock, 10 bits per Component Mapping for YUV 4:2:0 Even Line

59:50	49:40	39:30	29:20	19:10	9:0
			Y1		Y0

Figure 2-6: Dual Pixels per Clock, 10 bits per Component Mapping for YUV 4:2:0 Odd Line

READY/VALID Handshake

A valid transfer occurs whenever READY, VALID, and AP_RST_N are High at the rising edge of AP_CLK, as seen in Figure 2-7. During valid transfers, DATA only carries active video data. Blank periods and ancillary data packets are not transferred through the AXI4-Stream video protocol.

Guidelines on Driving s_axis_video_tvalid

Once s_axis_video_tvalid is asserted, no interface signals (except the TPG core driving s_axis_video_tready) may change value until the transaction completes (s_axis_video_tready, s_axis_video_tvalid, and AP_RST_N are high on the rising edge of AP_CLK). Once asserted, s_axis_video_tvalid may only be deasserted after a transaction has completed. Transactions may not be retracted or aborted. In any cycle following a transaction, s_axis_video_tvalid can either be deasserted or remain asserted to initiate a new transfer.

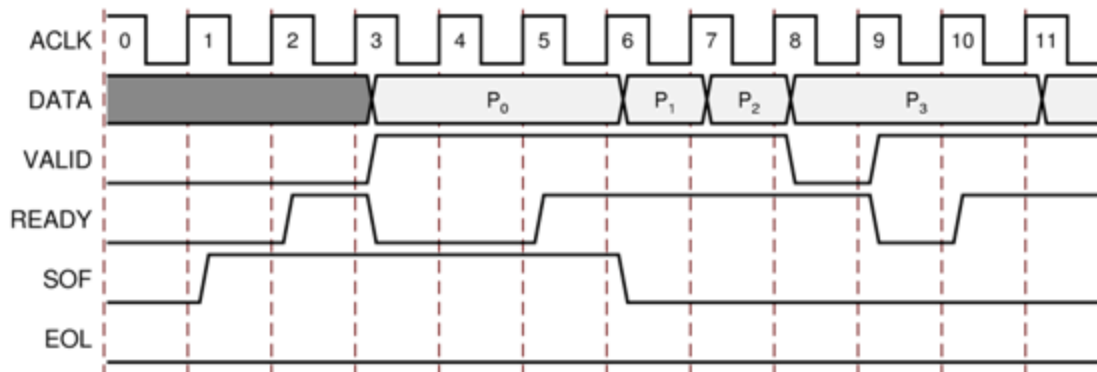

Figure 2-7: Example of READY/VALID Handshake, Start of a New Frame

Guidelines on Driving m_axis_video_tready

The m_axis_video_tready signal may be asserted before, during or after the cycle in which the TPG core asserted m_axis_video_tvalid. The assertion of m_axis_video_tready may be dependent on the value of m_axis_video_tvalid. A slave that can immediately accept data qualified by m_axis_video_tvalid, should pre-assert its m_axis_video_tready signal until data is received. Alternatively, m_axis_video_tready can be registered and driven the cycle following VALID assertion.



RECOMMENDED: To minimize latency, your custom core's slave interface should drive *READY* independently, or pre-assert *READY*.

Start of Frame Signals - *m_axis_video_tuser0*, *s_axis_video_tuser0*

The Start-Of-Frame (SOF) signal, physically transmitted over the AXI4-Stream *TUSER0* signal, marks the first pixel of a video frame. The SOF pulse is 1 valid transaction wide, and must coincide with the first pixel of the frame, as seen in Figure 2-7. The SOF signal serves as a frame synchronization signal, which allows downstream cores to re-initialize, and detect the first pixel of a frame. The SOF signal may be asserted an arbitrary number of *AP_CLK* cycles before the first pixel value is presented on *DATA*, as long as a *VALID* is not asserted.

End of Line Signals - *m_axis_video_tlast*, *s_axis_video_tlast*

The End-Of-Line (EOL) signal, physically transmitted over the AXI4-Stream *TLAST* signal, marks the last pixel of a line. The EOL pulse is 1 valid transaction wide, and must coincide with the last pixel of a scanline, as seen in Figure 2-8.

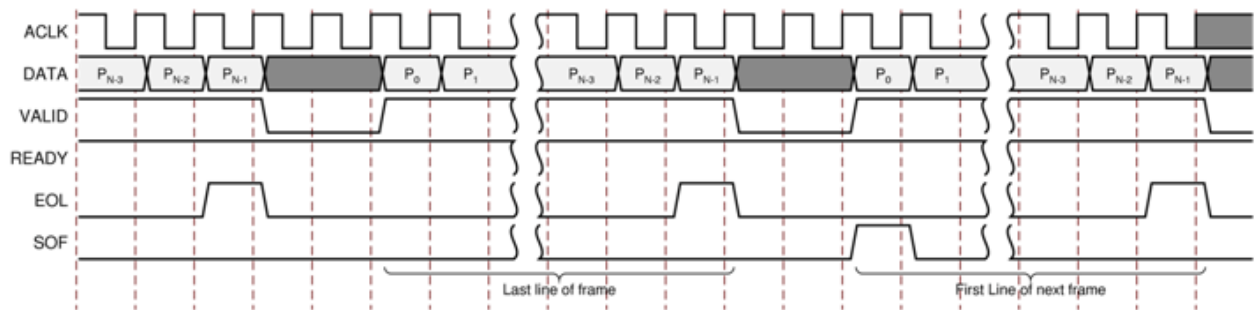

Figure 2-8: Use of EOL and SOF Signals

Control Interface

The AXI4-Lite register interface dynamically controls the behavior of the core. The AXI4-Lite slave interface facilitates integrating the core into a processor system, or along with other video or AXI4-Lite compliant IP, connected through AXI4-Lite interface to an AXI4-Lite master. The core cannot be instantiated without the AXI4-Lite control interface.

AXI4-Lite Interface

The AXI4-Lite interface allows you to dynamically control parameters within the core. Core configuration can be accomplished using an AXI4-Lite master state machine, or an embedded Arm® or soft system processor such as MicroBlaze™.

The TPG core can be controlled through the AXI4-Lite interface by using functions provided by the driver in the Vitis™ software platform. Another method is performing read and write

transactions to the TPG register space but should only be used when the first method is not available.

Table 2-3: AXI4-Lite Interface Signals

Signal Name	Direction	Width	Description
s_axi_CTRL_awvalid	In	1	AXI4-Lite Write Address Channel Write Address Valid.
s_axi_CTRL_awready	Out	1	AXI4-Lite Write Address Channel Write Address Ready. Indicates DMA ready to accept the write address.
s_axi_CTRL_awaddr	In	8	AXI4-Lite Write Address Bus
s_axi_CTRL_wvalid	In	1	AXI4-Lite Write Data Channel Write Data Valid.
s_axi_CTRL_wready	Out	1	AXI4-Lite Write Data Channel Write Data Ready. Indicates DMA is ready to accept the write data.
s_axi_CTRL_wdata	In	32	AXI4-Lite Write Data Bus
s_axi_CTRL_bresp	Out	2	AXI4-Lite Write Response Channel. Indicates results of the write transfer.
s_axi_CTRL_bvalid	Out	1	AXI4-Lite Write Response Channel Response Valid. Indicates response is valid.
s_axi_CTRL_bready	In	1	AXI4-Lite Write Response Channel Ready. Indicates target is ready to receive response.
s_axi_CTRL_arvalid	In	1	AXI4-Lite Read Address Channel Read Address Valid
s_axi_CTRL_arready	Out	1	Ready. Indicates DMA is ready to accept the read address.
s_axi_CTRL_araddr	In	8	AXI4-Lite Read Address Bus
s_axi_CTRL_rvalid	Out	1	AXI4-Lite Read Data Channel Read Data Valid
s_axi_CTRL_rready	In	1	AXI4-Lite Read Data Channel Read Data Ready. Indicates target is ready to accept the read data.
s_axi_CTRL_rdata	Out	32	AXI4-Lite Read Data Bus
s_axi_CTRL_rresp	Out	2	AXI4-Lite Read Response Channel Response. Indicates results of the read transfer.
s_axi_CTRL_wstrb	In	4	AXI4-Lite Write Strobe. Shows which bytes of the data bus are valid and should be read by the Slave.

Register Space

The core has 26 core-specific registers which allow you to dynamically control the operation of the core. All registers have initial value of 0. [Table 2-4](#) describes the register names.

Table 2-4: Register Names and Descriptions

Address (hex) BASEADDR +	Register Name	Access Type	Register Description
0x0000	Control	R/W	Bit 0: ap_start (R/W/COH) ⁽¹⁾ Bit 1: ap_done (R/COR) ⁽¹⁾ Bit 2: ap_idle (R) Bit 3: ap_ready (R) Bit 7: auto_restart (R/W) Others: reserved
0x0004	Global Interrupt Enable	R/W	Bit 0: Global Interrupt Enable Others: reserved This register is not used but reserved for future use.
0x0008	IP Interrupt Enable Register	R/W	Bit 0: Channel 0 (ap_done) Bit 1: Channel 1 (ap_ready) Others: reserved This register is not used but reserved for future use.
0x000C	IP Interrupt Status Register	R	Bit 0: Channel 0 (ap_done) Bit 1: Channel 1 (ap_ready) Others: reserved This register is not used but reserved for future use.
0x0010	Active height	R/W	Number of Active Lines per Frame
0x0018	Active width	R/W	Number of Active Pixels per Scanline
0x0020	Background pattern ID	R/W	Background pattern selection.
0x0028	Overlay ID	R/W	Foreground pattern selection.
0x0030	Mask ID	R/W	Color mask selection.
0x0038	Motion speed	R/W	How quickly the temporal features of the supported test pattern change from frame to frame
0x0040	Color format	R/W	Specify video color format
0x0048	Cross hair horizontal	R/W	Horizontal cross hair location
0x0050	Cross hair vertical	R/W	Vertical cross hair location
0x0058	zplate horizontal starting point	R/W	Set a starting point based sinusoidal values for the horizontal component

Table 2-4: Register Names and Descriptions (Cont'd)

Address (hex) BASEADDR +	Register Name	Access Type	Register Description
0x0060	zplate horizontal delta	R/W	Manipulates how quickly the horizontal component changes
0x0068	zplate vertical starting point	R/W	Set a starting point based sinusoidal values for the vertical component
0x0070	zplate vertical delta	R/W	Manipulates how quickly the vertical component changes
0x0078	Box size	R/W	Size of the box in pixel x pixel Bit [7:0]: Width of the box Bit [15:8]: Height of the box Since it is a NxN box, width and height are same.
0x0080	Box Color R and Y	R/W	Red, Y component value of the box
0x0088	Box Color G and U	R/W	Green, U component value of the box
0x0090	Box Color B and V	R/W	Blue, V component value of the box
0x0098	Enable input	R/W	Indicate whether to make use of video stream entering slave AXI4-Stream video interface. Takes effect only when AXI4-Stream slave interface is enabled.
0x00A0	Pass through left boundary	R/W	Left boundary (inclusively) of pass through window of video stream entering slave AXI4-Stream video interface. Takes effect only when AXI4-Stream slave interface is enabled.
0x00A8	Pass through right boundary	R/W	Right boundary (exclusively) of pass through window of video stream entering slave AXI4-Stream video interface. Takes effect only when AXI4-Stream slave interface is enabled.
0x00B0	Pass through upper boundary	R/W	Upper boundary (inclusively) of pass through window of video stream entering slave AXI4-Stream video interface. Takes effect only when AXI4-Stream slave interface is enabled.
0x00B8	Pass through lower boundary	R/W	Lower boundary (exclusively) of pass through window of video stream entering slave AXI4-Stream video interface. Takes effect only when AXI4-Stream slave interface is enabled.
0x00C0	Display port dynamic change	R/W	Dynamic range of DisplayPort color square in RGB. Takes effect only when DisplayPort color square pattern is selected.

Table 2-4: Register Names and Descriptions (Cont'd)

Address (hex) BASEADDR +	Register Name	Access Type	Register Description
0x00C8	Display port YUV coefficients	R/W	Co-efficients of DisplayPort color square in YUV. Takes effect only when DisplayPort color square pattern is selected.
0x00D0	Field ID	R/W	Used to configure the Field ID port of this block. Takes effect only for interlaced video content. Default value is 0. Bit 0: Progressive or Interlaced bit 0 - Progressive 1 - Interlaced Bit 1: Polarity bit 0 - Low during Field 0 and High during Field 1 1 - High during Field 0 and Low during Field 1 Bit 2: Passthrough enable bit 0 - Generator mode 1 - Passthrough mode Bit [31:3]: Reserved.
0x00D8	Back Motion Enable	R/W	Enables or disables the horizontal motion of the color bars pattern. 0x0 - Disable motion 0x1 - Enable motion

Notes:

1. COH = Clear on Handshake, COR = Clear on Read
2. Control Register (0x0000), Global Interrupt Enable Register (0x0004), IP Interrupt Enable Register (0x0008), and IP Interrupt Status Register (0x000C) are explained in section S_AXILITE Control Register Map of *Vitis High-Level Synthesis User Guide* (UG1399) [Ref 21]. These registers definitions may have some additional bits; however, in the current IP, you are accessing only bits mentioned in Table 2-4. Therefore, only these bits need to be considered while accessing the Control Register, Global Interrupt Enable Register, IP Interrupt Enable Register, and IP Interrupt Status Register.

Control (0x0000) Register

The control register controls the operation of the core. Bit[0] of the Control register, `ap_start`, kicks off the core from software. Writing 1 to this bit, starts the core to generate a video frame.

Bit[1] of the Control register, `ap_done`, indicates when the IP has completed all operations in the current transaction. A logic 1 on this signal indicates that the IP has completed all operations in this transaction.

Bit[2] of the Control register, `ap_idle`, signal indicates if the IP is operating or idle (no operation). The idle state is indicated by logic 1. This signal is asserted low once the IP starts operating. This signal is asserted high when the IP completes operation and no further operations are performed.

Bit[3] of the Control register, `ap_ready`, signal indicates when the IP is ready for new inputs. It is set to logic 1 when the IP is ready to accept new inputs, indicating that all input reads for this transaction are completed. If the IP has no operations in the pipeline, new reads are not performed until the next transaction starts. This signal is used to make a decision on when to apply new values to the input ports and whether to start a new transaction.

Bit[7] of the Control register, `auto_restart`, can be set to enable the auto-restart mode. Thereafter, the IP restarts automatically at the end of each transaction.

Active Height (0x0010) Register

The Active Height register encodes the number of active scan lines per frame. Supported values are between 64 and the value provided in the Maximum number of Rows field in the GUI. To avoid processing errors, you should restrict values written to active height to the range supported by the core instance. While configuring the interlaced resolution, the active height should be configured as half (active height/2).

Active Width (0x0018) Register

The Active Width register encodes the number of active pixels per scan. Supported values are 64 and the value provided in the Maximum number of Columns field in the GUI. To avoid processing errors, you should restrict values written to active width to the range supported by the core instance.

Background Pattern ID (0x0020) Register

The Background Pattern ID register controls the majority of the pattern manipulations that the TPG core produces.

This register controls which patterns are generated on the output of the core based on the following values:

- 0x00 - Pass the video input straight through the video output
- 0x1 - Horizontal Ramp which increases each component (RGB or Y) horizontally by 1
- 0x2 - Vertical Ramp which increases each component (RGB or Y) vertically by 1
- 0x3 - Temporal Ramp which increases every pixel by a value set in the motion speed register for every frame.
- 0x4 - Solid red output
- 0x5 - Solid green output
- 0x6 - Solid blue output
- 0x7 - Solid black output

- 0x8 - Solid white output
- 0x9 - Color bars
- 0xA - Zone Plate output produces a ROM based sinusoidal pattern. This option has dependencies on the motion speed, zplate horizontal starting point, zplate horizontal delta, zplate vertical starting point, and zplate vertical delta registers.
- 0xB - Tartan Color Bars
- 0xC - Draws a cross hatch pattern
- 0xD - Color sweep pattern
- 0xE - A combined vertical and horizontal ramp
- 0xF - Black and white checker board
- 0x10 - Pseudorandom pattern
- 0x11 - DisplayPort color ramp
- 0x12 - DisplayPort black and white vertical lines
- 0x13 - DisplayPort color square

In addition to setting the background pattern ID register with the correct value, the relative pattern category must be enabled when customizing IP to generate a desired pattern during runtime. If some pattern categories are disabled, the TPG generates a pure black screen when the background pattern ID register is configured with a pattern in a disabled category. For more information about the background pattern categorization, refer to [Chapter 4, Design Flow Steps](#).

Overlay ID (0x0028) Register

The Overlay ID register controls the overlay pattern on top of background pattern (100% opaque).

This register controls which overlay patterns based on the following values:

- 0x0 - No overlay pattern.
- 0x1 - Enables a moving box to be drawn over the video output. This option is dependent on the box size, Box Color R and Y, Box Color G and U, and Box Color B and V registers.
- 0x2 - Draws cross hairs one pixel in width on the output of the video. This feature depends on the cross hair horizontal and cross hair vertical register.

The Overlay ID register takes effects only when the Foreground Patterns parameter is enabled when customizing IP. If Foreground Patterns is disabled, no foreground pattern appears regardless of which pattern is selected in Overlay ID register.

Mask ID

The Mask ID register only takes effect on RGB video format. It controls mask-out of a particular color component.

- 0x0 - No masking
- 0x1 - Mask out the red component
- 0x2 - Mask out the green component
- 0x4 - Mask out the blue component

Motion Speed (0x0038) Register

This register cause the ramps, box and zone plate to increment by that value every frame.

- bit [7:0] - motion speed [7:0] (Read/Write)

Color Format (0x0040) Register

This register specifies the video format that the TPG core produces. It should match the input video format if AXI4-Stream slave interface is enabled in the GUI.

- 0x0 - RGB video format
- 0x1 - YUV 444 video format
- 0x2 - YUV 422 video format
- 0x3 - YUV 420 video format

Cross Hair Horizontal (0x0048) Register

The column of the frame that has the horizontal line of the cross hairs. This register takes effect only when Foreground Pattern (0x0020) is set to 2.

Cross Hair Vertical (0x0050) Register

The row of the frame that has the vertical line of the cross hairs. This register takes effect only when Foreground Pattern (0x0020) is set to 2.

ZPlate Horizontal Starting Point (0x0058) Register

The ZPlate Horizontal Starting Point register sets how widely spaced the horizontal component of a sine function are placed together. The larger the number, the more narrow the spacing.

ZPlate Horizontal Delta (0x0060) Register

This register controls the horizontal component speed by manipulating the indexing into the ROM table that contains the sinusoidal values.

ZPlate Vertical Starting Point (0x0068) Register

The ZPlate vertical starting point register sets the vertical component starting point in the ROM table that contains the sinusoidal values.

ZPlate Vertical Delta (0x0070) Register

This register controls the vertical component speed by manipulating the indexing into the ROM table that contains the sinusoidal values.

Box Size (0x0078) Register

The Box Size register defines the size of overlying box, where N represents NxN size of box. It is NxN for progressive video and Nx2N for interlaced video. The size of the box has to be set smaller than the frame size that is set in the Active Height and Active Width register. This register relies on value of foreground pattern (0x0020). If foreground pattern register is 1, the box is enabled; otherwise the box is disabled.

Box Color R and Y (0x0080) Register

Red, Y (for YUV mode) color component of the box.

Box Color G and U (0x0088) Register

Green, U (for YUV mode) color component of the box.

Box Color B and V (0x0090) Register

Blue, V (for YUV mode) color component of the box.

Enable Input (0x0098) Register

The Enable Input register indicate whether to make use of video stream entering slave AXI4-Stream video interface.

- 0x0 - Ignore the input video stream. The IP works the same way as AXI4-Stream slave is disabled although it has `s_axi_video` interface and connection.
- 0x1 - Make use of input video stream.

Pass Through Left Boundary (0x00a0) Register

The TPG IP can pass through part of input video stream inside an upright rectangle straight through video output as part of background pattern when AXI4-Stream slave interface is enabled. The pass-through window takes precedence over the regular background pattern at the same location. The Pass Through Left Boundary register specifies the left boundary (inclusively) of pass through window.

Pass Through Right Boundary (0x00a8) Register

The Pass Through Right Boundary register specifies the right boundary (exclusively) of pass through window.

Pass Through Upper Boundary (0x00b0) Register

The Pass Through Upper Boundary register specifies the upper boundary (inclusively) of pass through window.

Pass Through Lower Boundary (0x00b8) Register

The Pass Through Lower Boundary register specifies the lower boundary (exclusively) of pass through window.



IMPORTANT: *Note that in pass through window registers, the left and top boundaries are inclusive while the right and bottom are exclusive. For example, to pass through a top-left 720P window, these four registers should be set to (0, 0, 1280, 720), respectively, rather than (0, 0, 1279, 719).*

Display Port Dynamic Change (0x00c0) Register

This register specifies the dynamic range of DisplayPort color square definition in RGB. The default value is VESA.

- 0x0 - VESA
- 0x1 - CEA

Display Port YUV Coefficients (0x00c8) Register

This register specifies the coefficients of DisplayPort color square definition in YUV.

- 0x0 - coefficients 601
- 0x1 - coefficients 709

Field ID (0x00d0) Register

This register helps in configuration of interlaced video content.

- 0x0 - Progressive mode
- 0x1 - Interlaced mode
- 0x2 - Progressive mode with reverse polarity
- 0x3 - Interlaced mode with reverse polarity
- 0x4 - Passthrough mode

Back Motion Enable (0x00d8) Register

This register helps in enabling and disabling the horizontal motion of the Color Bars Pattern.

- 0x0 - Disable Motion
- 0x1 - Enable Motion

Designing with the Core

General Design Guidelines

The TPG core provides a variety of test patterns to test a video processing core or system by feeding known patterns through the Video over AXI4-Stream interface.

The core accepts video data provided through an AXI4-Stream slave interface (when configured with a slave interface), outputs pixels through an AXI4-Stream master interface, and can be controlled through an AXI4-Lite interface. The TPG block cannot change the input/output image sizes, the input and output pixel clock rates, or the frame rate.

A typical example design of the Test Pattern Generator core is shown in [Figure 3-1](#). For more information about the Video Test pattern generator Example Design, refer to [Chapter 5, Detailed Example Design](#).

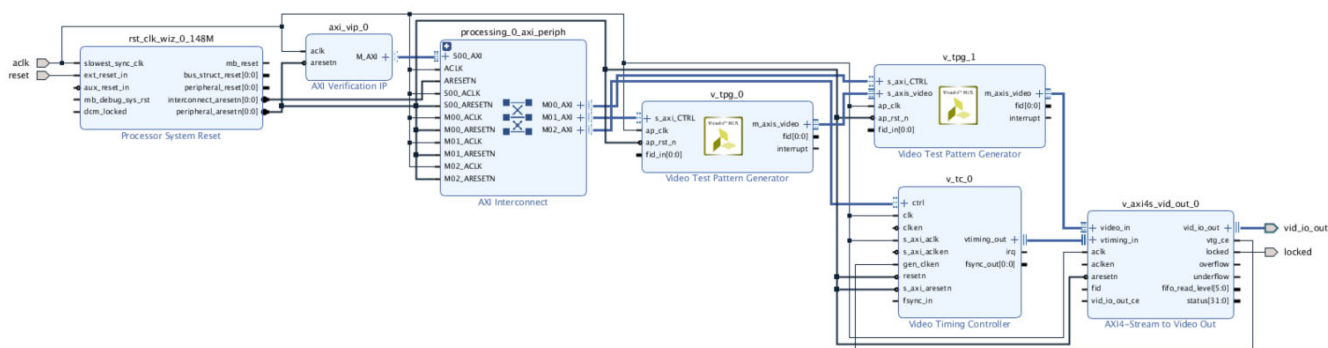

Figure 3-1: Example System with Video Test Pattern Generator Core

Clock, Enable, and Reset Considerations

AP_CLK

The master and slave AXI4-Stream video interfaces use the AP_CLK clock signal as their shared clock reference, as shown in Figure 3-2.

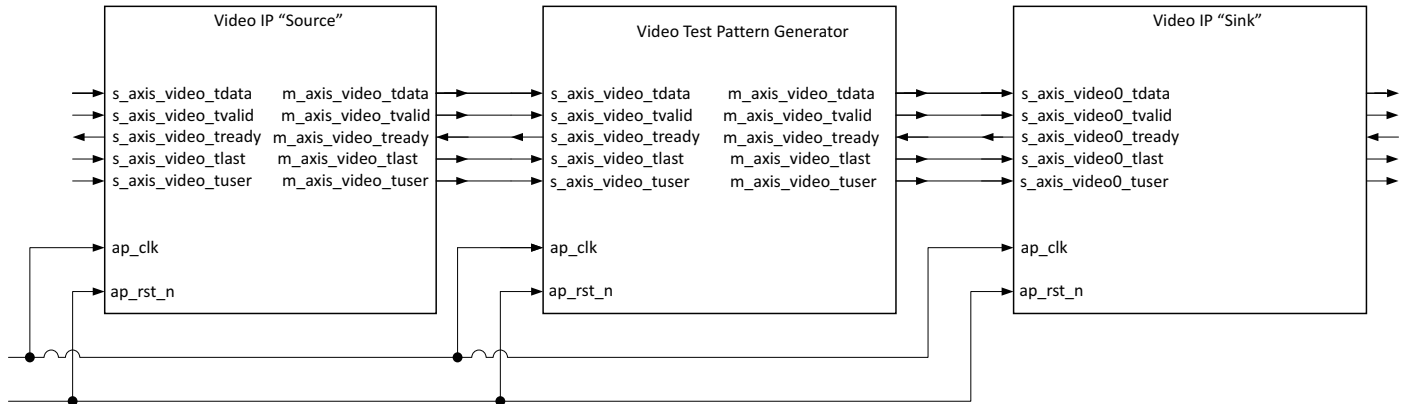

Figure 3-2: Example of AP_CLK Routing in an ISP Processing Pipeline

The AXI4-Lite interface also uses the AP_CLK pin as its clock source. The AP_CLK pin is shared between the AXI4-Lite and AXI4-Stream interfaces.

AP_RST_N

The Video Test Pattern Generator core has only a hardware reset option - the AP_RST_N pin. No software reset option is available.

The external reset pulse needs to be held for 16 or more AP_CLK cycles to reset the core. The AP_RST_N signal is synchronous to the AP_CLK clock domain. The AP_RST_N signal resets the entire core including the AXI4-Lite and AXI4-Stream interfaces.

System Considerations

The Video Test Pattern Generator IP core must be configured for the actual input image frame-size to operate properly. To gather the frame size information from the image video stream, it can be connected to the Video In to AXI4-Stream input and the Video Timing Controller. The timing detector logic in the Video Timing Controller gathers the video timing signals. The AXI4-Lite control interface on the Video Timing Controller allows the system processor to read out the measured frame dimensions, and program all downstream cores, such as the TPG, with the appropriate image dimensions.

When the Video Test Pattern Generator switches from Pass Through mode to generating a test pattern, the TPG uses an internal timing mechanism to produce Video over AXI4-Stream timing information.

Programming Sequence

All TPG processing parameters other than image size can be changed dynamically and the change is picked up immediately. If the image size needs to be changed on the fly or the entire system needs to be restarted, it is recommended that pipelined Xilinx[®] IP video cores are disabled/reset from system output towards the system input, and programmed/enabled from system output to system input.

Note: A reset to the IP is required when the TPG is switched from passthrough mode to generate mode or from generate mode to passthrough mode.

Design Flow Steps

This chapter describes customizing and generating the core, constraining the core, and the simulation, synthesis and implementation steps that are specific to this IP core. More detailed information about the standard Vivado® design flows and the IP integrator can be found in the following Vivado Design Suite user guides:

- *Vivado Design Suite User Guide: Designing IP Subsystems using IP Integrator* (UG994) [\[Ref 8\]](#)
- *Vivado Design Suite User Guide: Designing with IP* (UG896) [\[Ref 3\]](#)
- *Vivado Design Suite User Guide: Getting Started* (UG910) [\[Ref 6\]](#)
- *Vivado Design Suite User Guide: Logic Simulation* (UG900) [\[Ref 7\]](#)

Customizing and Generating the Core

You can customize the IP for use in your design by specifying values for the various parameters associated with the IP core using the following steps:

1. Select the IP from the IP catalog.
2. Double-click on the selected IP or select the Customize IP command from the toolbar or popup menu.

For details, see the sections, “Working with IP” and “Customizing IP for the Design” in the *Vivado® Design Suite User Guide: Designing with IP* (UG896) [\[Ref 3\]](#) and the “Working with the Vivado IDE” section in the *Vivado Design Suite User Guide: Getting Started* (UG910) [\[Ref 6\]](#).

If you are customizing and generating the core in the Vivado IP Integrator, see the *Vivado Design Suite User Guide: Designing IP Subsystems Using IP Integrator* (UG994) [\[Ref 8\]](#) for detailed information. IP Integrator might auto-compute certain configuration values when validating or generating the design. To check whether the values do change, see the description of the parameter in this chapter. To view the parameter value you can run the `validate_bd_design` command in the Tcl console.

Note: Figures in this chapter are illustrations of the Vivado IDE. This layout might vary from the current version.

Interface

The Xilinx® Video Test Pattern Generator (TPG) core is easily configured to meet your specific needs through the Vivado Design Suite. This section provides a quick reference to parameters that can be configured at generation time.

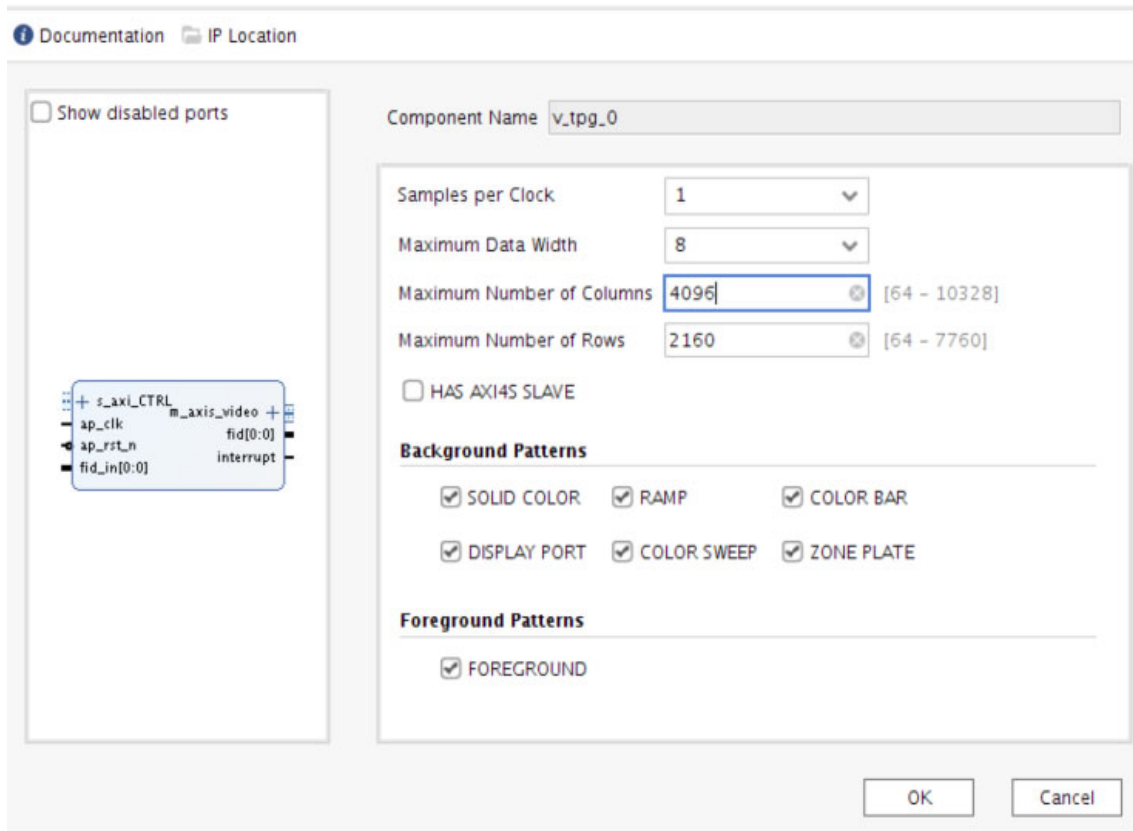

Figure 4-1: Customize IP Screen

The screen displays a representation of the IP symbol on the left side, and the parameter assignments on the right side, which are described as follows:

- **Component Name:** The component name is used as the base name of output files generated for the module. Names must begin with a letter and must be composed from characters: a to z, 0 to 9 and "_".
- **Samples Per Clock:** Specifies the number of pixel processed per clock cycle. Permitted values are 1, 2, 4, and 8 samples per clock. This parameter determines IP's throughput. The more samples per clock, the larger throughput it provides. The larger throughput always needs more hardware resources.
- **Maximum Data Width:** Specifies the bits per component of input samples when the core is in pass-through mode and defines the size (bits per component) of the

generated stream when in generator mode. Permitted values are 8, 10, 12, and 16 bits. This parameter should match the Video Component Width of the video IP core connected to the master and slave AXI4-Stream video interfaces. This value is static and is not configurable during runtime.

- **Maximum Number of Columns:** Specifies maximum video columns/pixels the IP core could produce at runtime. Any video width that is less than Maximum Number of Columns can be programmed through AXI4-Lite control interface without regenerating core.
- **Maximum Number of Rows:** Specifies maximum video rows/lines the IP core could produce at runtime. Any video height that is less than Maximum Number of Rows can be programmed through AXI4-Lite control interface without regenerating core.
- **Enable AXI4-Stream Slave interface:** When checked, the core can feed the video input stream through. When unchecked, the core can operate without a video input stream producing only the test patterns that the TPG can generate.
- **Solid Color:** Specifies whether to enable solid color patterns. Check the box when solid color patterns are desired during runtime; otherwise uncheck the box to save resources and improve timing performance. The solid color category contains solid red (0x04), solid green (0x05), solid blue (0x06), solid black (0x07), and solid white (0x08) described under Background Pattern ID register in [Chapter 2, Product Specification](#).
- **Ramp Pattern:** Specifies whether to enable ramp patterns. Check the box when ramp pattern are desired during runtime; otherwise uncheck the box to save resources and improve timing performance. This category contains horizontal ramp (0x1), vertical ramp (0x2), temporal ramp (0x3), and combined vertical and horizontal ramp (0xE).
- **Color Bar:** Specifies whether to enable color bar patterns. Check the box when color bar patterns are desired during runtime; otherwise uncheck the box to save resources and improve timing performance. This category has color bars (0x9), Tartan color bars (0xB), cross hatch (0xC), and black and white checker board (0xF).
- **DisplayPort:** Specifies whether to enable DisplayPort patterns. Check the box when DisplayPort patterns are desired during runtime; otherwise uncheck the box to save resources and improve timing performance. The DisplayPort color ramp (0x11), Displayport black and white vertical lines (0x12) and DisplayPort color square (0x13) are among this category.
- **Color Sweep:** Specifies whether to enable color sweep pattern. Check the box when color sweep pattern is desired during runtime; otherwise uncheck the box to save resources and improve timing performance. Color sweep (0xD) is the only pattern is this category.
- **Zone Plate:** Specifies whether to enable zone plate pattern. Check the box when zone plate pattern is desired during runtime; otherwise uncheck the box to save resources and improve timing performance. Zone Plate (0xA) is the only pattern is this category.

- **Foreground Patterns:** Specifies whether to enable foreground patterns. Check the box when foreground patterns are desired during runtime; otherwise uncheck the box to save resources and improve timing performance.

Output Generation

For details, see “Generating IP Output Products” in the *Vivado Design Suite User Guide: Designing with IP* (UG896) [Ref 3].

Constraining the Core

This section contains information about constraining the core in the Vivado Design Suite.

Required Constraints

The only constraints required are clock frequency constraints for the core clock, `ap_clk`. Paths from AXI4-Lite signals should be constrained with a `set_false_path`, causing setup and hold checks to be ignored for AXI4-Lite signals. These constraints are provided in the XDC constraints file included with the core.

Device, Package, and Speed Grade Selections

This section is not applicable for this IP core.

Clock Frequencies

This section is not applicable for this IP core.

Clock Management

This section is not applicable for this IP core.

Clock Placement

This section is not applicable for this IP core.

Banking

This section is not applicable for this IP core.

Transceiver Placement

This section is not applicable for this IP core.

I/O Standard and Placement

This section is not applicable for this IP core.

Simulation

For comprehensive information about Vivado simulation components, as well as information about using supported third party tools, see the *Vivado Design Suite User Guide: Logic Simulation* (UG900) [Ref 7].

Synthesis and Implementation

This section contains information about synthesis and implementation in the Vivado Design Suite. For details about synthesis and implementation, see "Synthesizing IP" and "Implementing IP" in the *Vivado Design Suite User Guide: Designing with IP* (UG896) [Ref 3].

Detailed Example Design

This chapter provides two example systems that include the Video Test Pattern Generator core. One is simulation example design and the other one is synthesizable example design. Important system-level aspects when designing with the Video Test Pattern Generator are highlighted in example designs, including:

- Video test pattern generator usage in AXI4-Stream Slave enable and disable mode.
- Typical usage of video test pattern generator in conjunction with other cores and AXI master.
- Configuration of video test pattern generation registers on the fly.

Note: The example project is only available on Xilinx® KC705 evaluation board.

Table 5-1: Example Design Support

Development Board	Additional Hardware	Processor	Topology
KC705	N/A	MicroBlaze	Generator or Passthrough
ZCU102	N/A	psu_cortexa53_0	Generator or Passthrough
ZCU104	N/A	psu_cortexa53_0	Generator or Passthrough
ZCU106	N/A	psu_cortexa53_0	Generator or Passthrough
VCK190	N/A	CIPS	Generator or Passthrough

To open the example project, perform following:

1. Select the **Video Test Pattern Generator IP** from IP Catalog.
2. Double-click on the selected IP or right-click the IP and select **Customize IP** from the menu.
3. Configure the build-time parameters in the **Customize IP** window and click **OK**. The Vivado® IDE generates an example design matching the build-time configuration.
4. In the **Generate Output Products** window, select **Generate** or **Skip**. If **Generate** is selected, the IP's output products are generated after a brief moment.
5. Right-click **TPG** in **Sources** panel and select **Open IP Example Design** from the menu.
6. In the **Open IP Example Design** window, select example project directory and click **OK**. The Vivado software then runs automation to generate example design in selected directory.

The generated project contains two example designs. Figure 5-1 shows the Source panel of the example project. Synthesizable example block design, along with top-level file, resides in Design Sources catalog. Corresponding constraint file is also provided for the synthesizable example design. Simulation example design files (including block design file, SystemVerilog test bench and another task file) are under Simulation Sources.

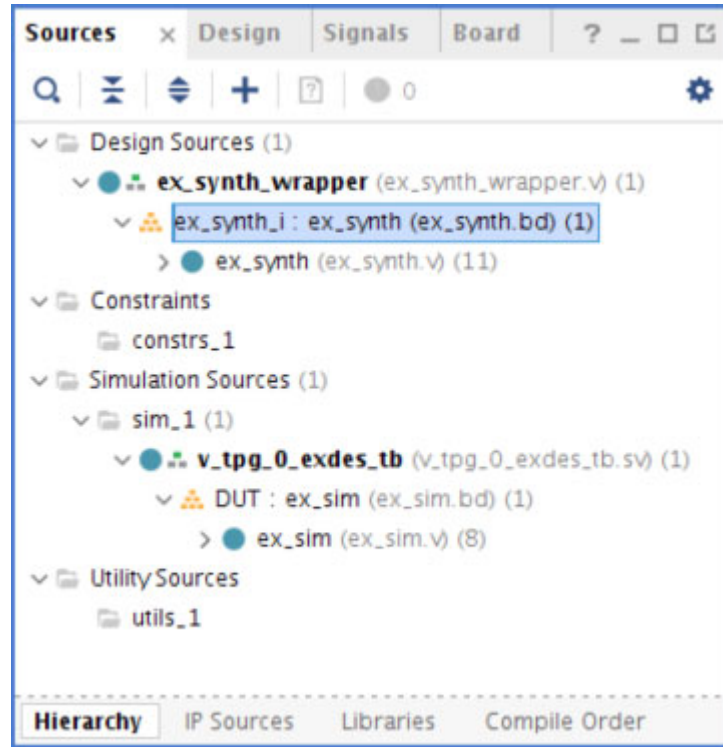

Figure 5-1: Example Project Source Panel

Synthesizable Example Design

The difference between the Synthesizable design and the Simulation example design is the use of the MicroBlaze™ microprocessor instead of the AXI VIP core as AXI master. The locked port of AXI4-Stream to Video Out is connected to axi_gpio_lock core and MicroBlaze polls the corresponding register for a sign that the test passed. Because this design runs on hardware, it demonstrates the accuracy of TPG cores running a large video frame.

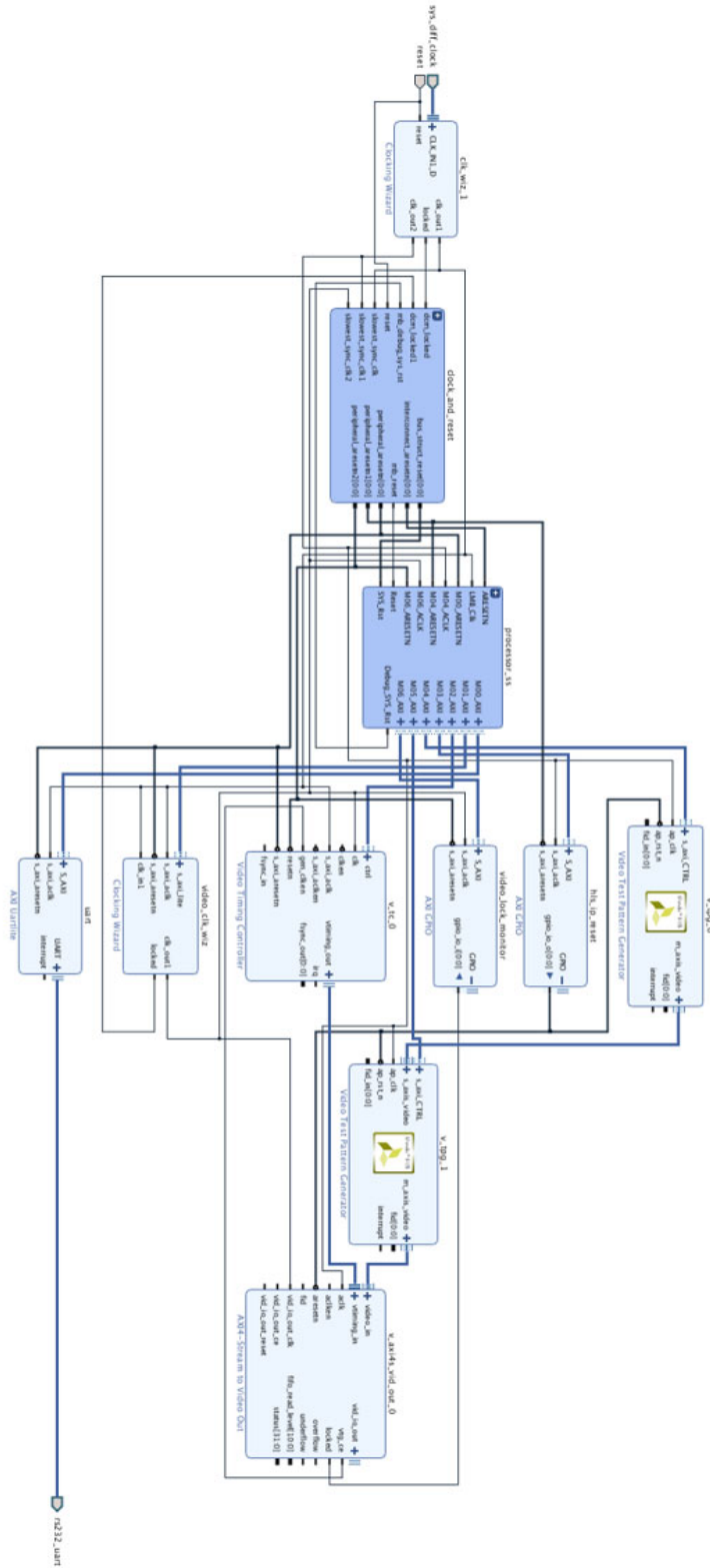

Figure 5-2: Synthesizable Example Block Design

The synthesizable example design requires both Vivado tools and the Vitis™ software platform.

The first step is to run synthesis, implementation and bitstream generation in Vivado. After all those steps are done, select **File -> Export -> Export Hardware**. In the window, select **Include bitstream**, select an export directory and click **OK**.

The remaining work is performed in the Vitis software platform. The TPG example design file can be found at Vitis directory:

```
(<install_directory>/release/data/embeddedsw/XilinxProcessorIPLib/drivers/
v_tpg_v8_3/examples/
```

Example application design source files (contained within "examples" folder) are tightly coupled with the v_tpg example design available in Vivado Catalog.

vtpg_example.tcl automates the process of generating the downloadable bit and elf files from the provided example xsa file.

To run the provided Tcl script:

1. Copy the exported example design hdf file in the "examples" directory of the driver
2. Launch the Xilinx Software Command-Line Tool (xsct) terminal
3. cd into the examples directory
4. Source the tcl file

```
xsct%>source vtpg_example.tcl
```

5. Execute the script

```
xsct%>vtpg_example <xsa_file_name.xsa>
```

The Tcl script cript performs the following:

- Create workspace
- Create HW project
- Create BSP
- Create Application Project
- Build BSP and Application Project

After the process is complete, the required files are available in:

```
bit file -> vtpg_example_hw_platform/hw folder
elf file -> vtpg_example.sdk/vtpg_example_design/{Debug/Release} folder
```

Next, perform the following steps to run the software application:



IMPORTANT: To do so, make sure that the hardware is powered on and a Digilent Cable or an USB Platform Cable is connected to the host PC. Also, ensure that a USB cable is connected to the UART port of the KC705 board.

1. Launch the Vitis™ software platform.
2. Set workspace to vtpg_example.sdk folder in prompted window. The Vitis project opens automatically. (If a welcome page shows up, close that page.)
3. Download the bitstream into the FPGA by selecting **Xilinx Tools > Program FPGA**. The Program FPGA dialog box opens.
4. Ensure that the Bitstream field shows the bitstream file generated by Tcl script, and then click **Program**.
Note: The DONE LED on the board turns green if the programming is successful.
5. A terminal program (HyperTerminal or PuTTY) is needed for UART communication. Open the program, choose appropriate port, set baud rate to 115200 and establish Serial port connection.
6. Select and right-click the application vtpg_example_design in Project_Explorer panel.
7. Select **Run As > Launch on Hardware (System Debugger)**.
8. Select Binaries and Qualifier in window and click **OK**.

The example design test result are shown in terminal program.

For more information, visit www.xilinx.com/tools/vitis.htm.

When executed on the board, the example application performs following:

- Program Video Clock Generator to 1080p@60 Hz
- Program TPG0 and TPG1 to 1080p@60 Hz
- Check for Video Lock and report the status (PASS/FAIL) on UART
- Repeat Steps 1-3 for 4KP@30 Hz and 4KP@60 Hz

Test Bench

No test bench is available at this time. For a comprehensive listing of Video and Imaging application notes, white papers, related IP cores including the most recent reference designs available, see the Video Design Hub at:

<https://www.xilinx.com/support/documentation-navigation/design-hubs/dh0083-video-hub.html>

Verification, Compliance, and Interoperability

Simulation

A highly parameterizable test bench was used to test the Video Test Pattern Generator core in Vitis™ HLS. Testing included the following:

- Register accesses
 - Processing multiple frames of data
 - Varying IP throughput and pixel data width
 - Testing Video Test Pattern Generator core in AXI4-Stream Slave enable and disable mode
 - Testing of various frame sizes
 - Varying parameter settings
-

Hardware Testing

The Video Test Pattern Generator core has been validated in hardware at Xilinx® to represent a variety of parameterizations, including the following:

- A test design was developed for the core that incorporated a MicroBlaze™ processor, AXI4-Lite interconnect and various other peripherals. The MicroBlaze processor was responsible for:
 - Programming the video clock to match tested video resolution
 - Configuring the TPG cores with different resolutions
 - Launching the test
 - Reporting the Pass/Fail status of the test and any errors that were found

Interoperability

The core slave (input) AXI4-Stream interface can work directly with any core that produces RGB, YUV 444, YUV 422 and YUV 420 video data.

Upgrading

This appendix contains information about migrating from an ISE design to the Vivado® Design Suite, and for upgrading to a more recent version of the IP core. For customers upgrading their IP core, important details (where applicable) about any port changes and other impact to user logic are included.

Migrating to the Vivado Design Suite

For information about migration to Vivado Design Suite, see *ISE to Vivado Design Suite Migration Guide* (UG911) [Ref 2].

Upgrading in Vivado Design Suite

This section provides information about any changes to the user logic or port designations that take place when you upgrade to a more current version of this IP core in the Vivado Design Suite.

Parameter Changes

There were no parameter changes.

Port Changes

The ports are enabled based on your configuration of the IP. As a result, the upgrade log for the TPG core shows warnings of detecting external port differences when upgrading IP from old versions. [Table B-1](#) shows the ports that might be affected.

Table B-1: Port Changes

Interface / Signal name	Comments
fid_in and fid	Ports added

Other Changes

The Video Test Pattern Generator v8.0 is an up revision of Video Test Pattern Generator v7.0 IP using Vivado HLS (along with new drivers). Compared to TPG v7.0, it has the following new features:

- Support added for interlaced video content. Added `fid_in` and `fid` ports for interlaced video support.
- Support added for 10k video resolution (max 15360 x 8640).
- Removed license from the core.

Migration Guidelines

Video Test Pattern Generator v8.1 is a direct replacement for v8.0. The IP features remain same but Vitis™ HLS tool will synthesize the IP instead of Vivado HLS tool:

- Addition of `fid_in` and `fid` ports

The TPG v8.0 has additional `fid_in` and `fid` ports which help in enable interlaced video support. In generator mode, the TPG generates `fid` to be sent to the external IP and in pass-through mode, the input `fid` to the IP via external IP, connected to `fid_in` is sent to external IP using the `fid` port. The connections to be made can be seen in [Figure B-1](#).

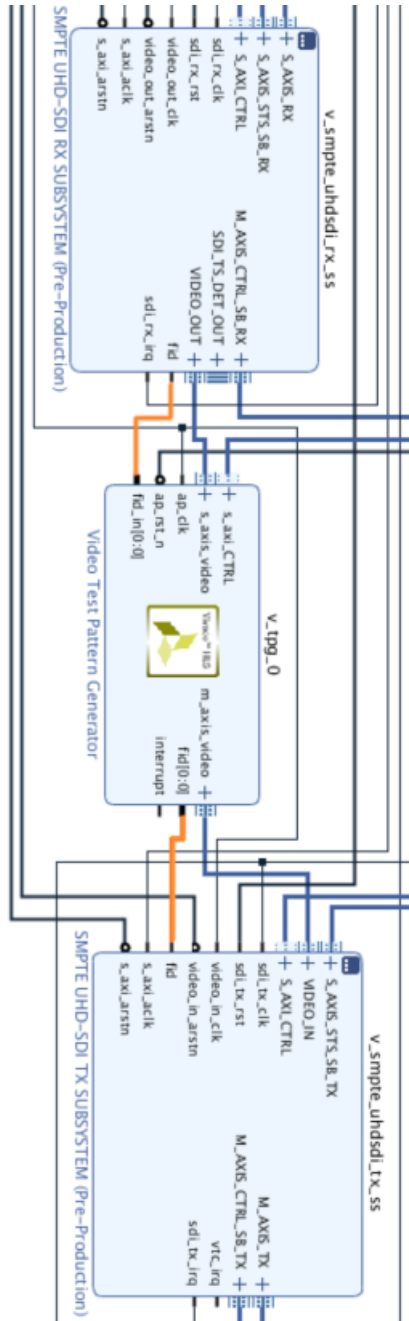

Figure B-1: Connection of the SDI RX and TX to TPG

Debugging

This appendix includes details about resources available on the Xilinx® Support website and debugging tools.

Finding Help on Xilinx.com

To help in the design and debug process when using the Video Test Pattern Generator, the [Xilinx Support web page](#) contains key resources such as product documentation, release notes, answer records, information about known issues, and links for obtaining further product support.

Documentation

This product guide is the main document associated with the Video Test Pattern Generator. This guide, along with documentation related to all products that aid in the design process, can be found on the [Xilinx Support web page](#) or by using the Xilinx Documentation Navigator.

Download the Xilinx Documentation Navigator from the [Downloads page](#). For more information about this tool and the features available, open the online help after installation.

Answer Records

Answer Records include information about commonly encountered problems, helpful information on how to resolve these problems, and any known issues with a Xilinx product. Answer Records are created and maintained daily ensuring that users have access to the most accurate information available.

Answer Records for this core are listed below, and can also be located by using the Search Support box on the main [Xilinx support web page](#). To maximize your search results, use proper keywords such as

- Product name
- Tool message(s)
- Summary of the issue encountered

A filter search is available after results are returned to further target the results.

Answer Records for the Video Test Pattern Generator Core

[AR 54536](#)

Technical Support

Xilinx provides technical support in the [Xilinx Support web page](#) for this LogiCORE™ IP product when used as described in the product documentation. Xilinx cannot guarantee timing, functionality, or support if you do any of the following:

- Implement the solution in devices that are not defined in the documentation.
- Customize the solution beyond that allowed in the product documentation.
- Change any section of the design labeled DO NOT MODIFY.

To contact Xilinx Technical Support, navigate to the [Xilinx Support web page](#).

Debug Tools

There are many tools available to address Video Test Pattern Generator core design issues. It is important to know which tools are useful for debugging various situations.

Vivado Design Suite Debug Feature

The Vivado® Design Suite debug feature inserts logic analyzer and virtual I/O cores directly into your design. The debug feature also allows you to set trigger conditions to capture application and integrated block port signals in hardware. Captured signals can then be analyzed. This feature in the Vivado IDE is used for logic debugging and validation of a design running in Xilinx devices.

The Vivado logic analyzer is used with the logic debug IP cores, including:

- ILA 2.0 (and later versions)
- VIO 2.0 (and later versions)

See *Vivado Design Suite User Guide: Programming and Debugging (UG908)* [Ref 5].

Hardware Debug

Hardware issues can range from link bring-up to problems seen after hours of testing. This section provides debug steps for common issues. The Vivado lab tools are a valuable

resource to use in hardware debug. The signal names mentioned in the following individual sections can be probed using the Vivado lab tools for debugging the specific problems.

General Checks

Ensure that all the timing constraints for the core were properly incorporated from the example design and that all constraints were met during implementation.

- Does it work in post-place and route timing simulation? If problems are seen in hardware but not in timing simulation, this could indicate a PCB issue. Ensure that all clock sources are active and clean.
- If using MMCMs in the design, ensure that all MMCMs have obtained lock by monitoring the `LOCKED` port.

Vivado Synthesis Debug

For tools released before 2018.3, the IP is licensed. Hence, check the licenses if the IP fails to build. On Windows, check the path lengths. For any other issues, the `vitis_hls.log` file, which is generated in the output folder of the Block Design, should be checked.

Additional Resources and Legal Notices

Xilinx Resources

For support resources such as Answers, Documentation, Downloads, and Forums, see [Xilinx Support](#).

For a comprehensive listing of Video and Imaging application notes, white papers, reference designs and related IP cores, see the Video Design Hub at:

<https://www.xilinx.com/support/documentation-navigation/design-hubs/dh0083-video-hub.html>

Documentation Navigator and Design Hubs

Xilinx® Documentation Navigator provides access to Xilinx documents, videos, and support resources, which you can filter and search to find information. To open the Xilinx Documentation Navigator (DocNav):

- From the Vivado® IDE, select **Help > Documentation and Tutorials**.
- On Windows, select **Start > All Programs > Xilinx Design Tools > DocNav**.
- At the Linux command prompt, enter `docnav`.

Xilinx Design Hubs provide links to documentation organized by design tasks and other topics, which you can use to learn key concepts and address frequently asked questions. To access the Design Hubs:

- In the Xilinx Documentation Navigator, click the **Design Hubs View** tab.
- On the Xilinx website, see the [Design Hubs](#) page.

Note: For more information on Documentation Navigator, see the [Documentation Navigator](#) page on the Xilinx website.

References

These documents provide supplemental material useful with this user guide:

1. *Vivado AXI Reference Guide* ([UG1037](#))
2. *ISE to Vivado Design Suite Migration Guide* ([UG911](#))
3. *Vivado Design Suite User Guide: Designing with IP* ([UG896](#))
4. *AXI4-Stream Video IP and System Design Guide* ([UG934](#))
5. *Vivado Design Suite User Guide: Programming and Debugging* ([UG908](#))
6. *Vivado Design Suite User Guide: Getting Started* ([UG910](#))
7. *Vivado Design Suite User Guide: Logic Simulation* ([UG900](#))
8. *Vivado Design Suite User Guide: Designing IP Subsystems Using IP Integrator* ([UG994](#))
9. *Kintex UltraScale FPGAs Data Sheet: DC and AC Switching Characteristics* ([DS892](#))
10. *Virtex UltraScale FPGAs Data Sheet: DC and AC Switching Characteristics* ([DS893](#))
11. *Kintex-7 FPGAs Data Sheet: DC and AC Switching Characteristics* ([DS182](#))
12. *Virtex-7 FPGAs Data Sheet: DC and AC Switching Characteristics* ([DS183](#))
13. *Artix-7 FPGAs Data Sheet: DC and AC Switching Characteristics* ([DS181](#))
14. *Zynq-7000 SoC (Z-7007S, Z-7012S, Z-7014S, Z-7010, Z-7015, and Z-7020) Data Sheet: DC and AC Switching Characteristics* ([DS187](#))
15. *Zynq-7000 SoC (Z-7030, Z-7035, Z-7045, and Z-7100) Data Sheet: DC and AC Switching Characteristics* ([DS191](#))
16. *Kintex UltraScale+ FPGAs Data Sheet: DC and AC Switching Characteristics* ([DS922](#))
17. *Virtex UltraScale+ FPGA Data Sheet: DC and AC Switching Characteristics* ([DS923](#))
18. *Zynq UltraScale+ MPSoC Data Sheet: DC and AC Switching Characteristics* ([DS925](#))
19. *Zynq UltraScale+ RFSoc Data Sheet: DC and AC Switching Characteristics* ([DS926](#))
20. *Versal AI Core Series Data Sheet: DC and AC Switching Characteristics* ([DS957](#))
21. *Vitis High-Level Synthesis User Guide* ([UG1399](#))

Revision History

The following table shows the revision history for this document.

Date	Version	Revision
11/04/2022	8.2	General updates.
05/11/2022	8.2	<ul style="list-style-type: none"> •Updated Register Names and Register Description in Table 2-4. •Updated Control (0x0000) Register in Chapter 2. •Updated Table 5-1.
11/10/2021	8.2	Added support for 15360 x 8640 resolution.
08/06/2021	8.1	Provided Versal Example design along with the IP.
02/04/2021	8.1	General updates.
12/17/2019	8.0	Updated the Synthesizable Design Section with new Vitis flow for software.
12/05/2018	8.0	Added interlaced video support. Added 10k video resolution support. Removed license from the core.
04/05/2017	7.0	Updated Customizing and Generating the Core section.
10/05/2016	7.0	Added DisplayPort patterns. Added 8 pixel-per-clock and 8K resolution supports. Provided pattern configurability and flexibility. Updated Xilinx automotive applications disclaimer.
11/18/2015	7.0	Added UltraScale+ support.
09/30/2015	7.0	Redesigned IP with Vivado HLS. Documented interface changes. Added example design.
10/01/2014	6.0	Removed Application Software Development appendix.
04/02/2014	6.0	Added Video Timing Input interface.
10/02/2013	5.0	Synch document version with core version. Updated Constraints and Test Bench chapters. Updated Migration appendix.
03/20/2013	1.1	Updated for core version. Removed ISE chapters.
12/18/2012	1.0	Initial Xilinx release of Product Guide.

Please Read: Important Legal Notices

The information disclosed to you hereunder (the "Materials") is provided solely for the selection and use of Xilinx products. To the maximum extent permitted by applicable law: (1) Materials are made available "AS IS" and with all faults, Xilinx hereby DISCLAIMS ALL WARRANTIES AND CONDITIONS, EXPRESS, IMPLIED, OR STATUTORY, INCLUDING BUT NOT LIMITED TO WARRANTIES OF MERCHANTABILITY, NON-INFRINGEMENT, OR FITNESS FOR ANY PARTICULAR PURPOSE; and (2) Xilinx shall not be liable (whether in contract or tort, including negligence, or under any other theory of liability) for any loss or damage of any kind or nature related to, arising under, or in connection with, the Materials (including your use of the Materials), including for any direct, indirect, special, incidental, or consequential loss or damage (including loss of data, profits, goodwill, or any type of loss or damage suffered as a result of any action brought by a third party) even if such damage or loss was reasonably foreseeable or Xilinx had been advised of the possibility of the same. Xilinx assumes no obligation to correct any errors contained in the Materials or to notify you of updates to the Materials or to product specifications. You may not reproduce, modify, distribute, or publicly display the Materials without prior written consent. Certain products are subject to the terms and conditions of Xilinx's limited warranty, please refer to Xilinx's Terms of Sale which can be viewed at <https://www.xilinx.com/legal.htm#tos>; IP cores may be subject to

warranty and support terms contained in a license issued to you by Xilinx. Xilinx products are not designed or intended to be fail-safe or for use in any application requiring fail-safe performance; you assume sole risk and liability for use of Xilinx products in such critical applications, please refer to Xilinx's Terms of Sale which can be viewed at <https://www.xilinx.com/legal.htm#tos>.

AUTOMOTIVE APPLICATIONS DISCLAIMER

AUTOMOTIVE PRODUCTS (IDENTIFIED AS "XA" IN THE PART NUMBER) ARE NOT WARRANTED FOR USE IN THE DEPLOYMENT OF AIRBAGS OR FOR USE IN APPLICATIONS THAT AFFECT CONTROL OF A VEHICLE ("SAFETY APPLICATION") UNLESS THERE IS A SAFETY CONCEPT OR REDUNDANCY FEATURE CONSISTENT WITH THE ISO 26262 AUTOMOTIVE SAFETY STANDARD ("SAFETY DESIGN"). CUSTOMER SHALL, PRIOR TO USING OR DISTRIBUTING ANY SYSTEMS THAT INCORPORATE PRODUCTS, THOROUGHLY TEST SUCH SYSTEMS FOR SAFETY PURPOSES. USE OF PRODUCTS IN A SAFETY APPLICATION WITHOUT A SAFETY DESIGN IS FULLY AT THE RISK OF CUSTOMER, SUBJECT ONLY TO APPLICABLE LAWS AND REGULATIONS GOVERNING LIMITATIONS ON PRODUCT LIABILITY.

© Copyright 2012-2022, Advanced Micro Devices, Inc. Xilinx, the Xilinx logo, Alveo, Artix, Kintex, Kria, Spartan, Versal, Virtex, Vivado, Zynq, and other designated brands included herein are trademarks of Xilinx in the United States and other countries. The DisplayPort Icon is a trademark of the Video Electronics Standards Association, registered in the U.S. and other countries. All other trademarks are the property of their respective owners. AMBA, AMBA Designer, Arm, Arm1176JZ-S, CoreSight, Cortex, PrimeCell, Mali, and MPCore are trademarks of Arm Limited in the EU and other countries. All other trademarks are the property of their respective owners.